

# USER'S MANUAL

## 1. DESCRIPTION

This converter allows the connection of any type of reader (Wiegand, Data / Clock ISO2, Dallas and RS-232) to the local bus of the access units. The converter automatically adapts its inputs (D1/CLK/Dal and DO/DTA/Rx) to the reader's output.

## 2. SPECIFICATIONS

- Current consumption without external elements: 30 mA
- Output 13,8 Vdc: max. 300 mA
- Tamper input
- Dimensions (mm): 54 x 30

## 3. DIP SWITCH AND TERMINAL BLOCKS DESCRIPTION

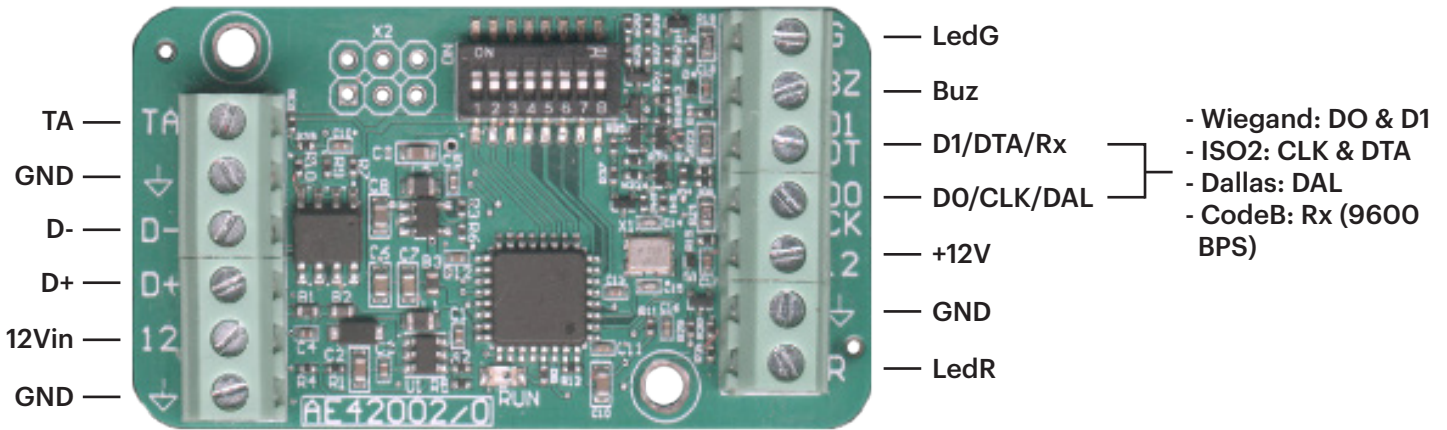

### Reader LEDs configuration

In order to configure the LEDs of your reader, check your reader manual and set the DIP Switch following the table below:

Readers LED colors		Orange		Red		Green		OFF	
DIP Switch position	Type	LedR	LedG	LedR	LedG	LedR	LedG	LedR	LedG
/	/	/	Z	/	Z	/	Z	/	Z
DIP 4	1 Wire	/	Z	/	LO	/	HI	/	Z
DIP 3	1 Wire	/	Z	/	HI	/	LO	/	Z
DIP 3 & 4	2 Wires	LO	LO	LO	Z	Z	LO	Z	Z
DIP 2	2 Wires	LO	LO	Z	LO	LO	Z	Z	Z
DIP 2 & 4	2 Wires	Z	Z	Z	LO	LO	Z	LO	LO
DIP 2 & 3	2 Wires	Z	Z	LO	Z	Z	LO	LO	LO
DIP 2, 3 & 4	2 Wires	HI	HI	HI	Z	Z	HI	Z	Z
DIP 1	2 Wires	HI	HI	Z	HI	HI	Z	Z	Z
DIP 1 & 4	2 Wires	Z	Z	Z	HI	HI	Z	HI	HI
DIP 1 & 3	2 Wires	Z	Z	HI	Z	Z	HI	HI	HI

**Legend**  
**Z:** Three state  
**LO:** 0 volt  
**HI:** +5 volts

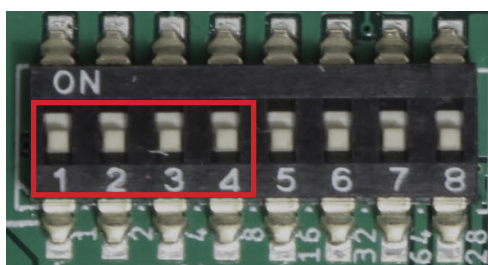

From version 2.03!!!

• **DIP switch 7 On:**

Wiegand mode: disables the possibility to use a Wiegand keypad.

• **DIP switch 7 Off:**

Wiegand mode: a Wiegand keypad can be used on the DO/D1 input;

The keypad must be configured in Single Key - 8 bits Wiegand - Nibbles Complemented.

• **DIP switch 8 On: Address 0.**

• **DIP switch 8 Off: Address 1.**

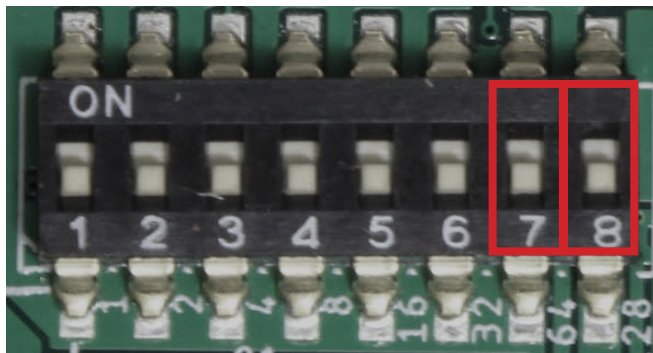

### 4. CONNECTION DIAGRAM

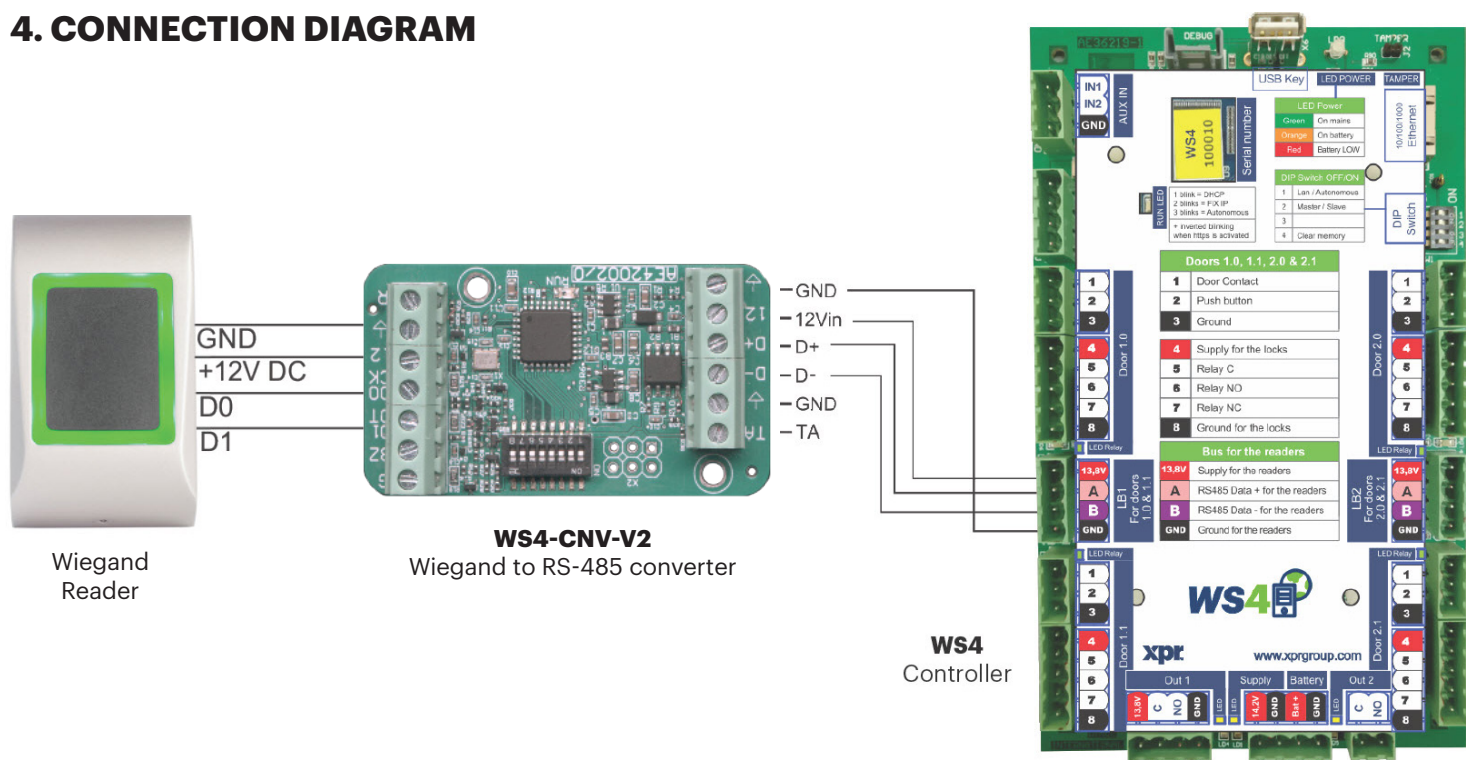

- Set the desired Wiegand Output of the reader.
- Connect the Wiegand Reader to the converter as shown in the picture above.
- Put the Address DIP Switch in the converter to the desired address, 0 or 1.
- Set the parameters for the reader in the WS4 software.

## 5. SOFTWARE SETTINGS

### 5.1 WIEGAND 26 BIT

- In the **Settings/Configuration of the readers** select **“Wiegand 26bit”**, the one shown in the picture below.

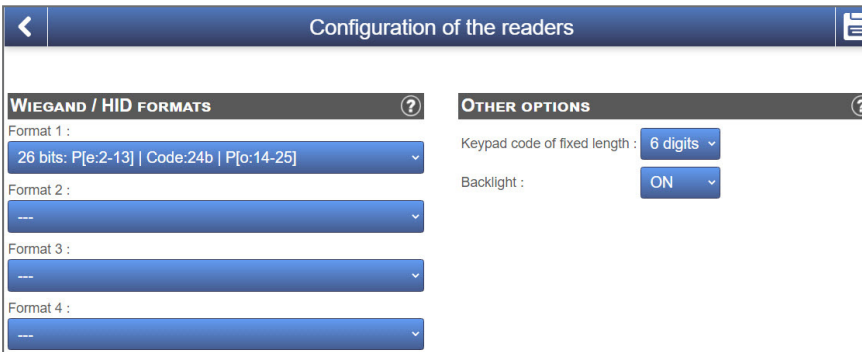
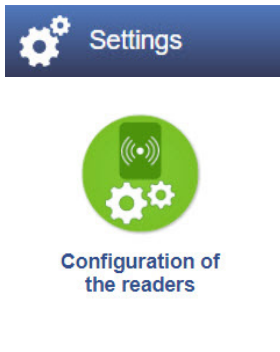

- In the **Doors/Reader/Card** tab select **“Wiegand (decoded)”**.

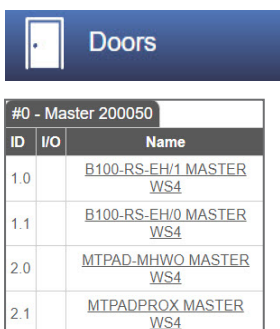

ID	I/O	Name
1.0		B100-RS-EH/1 MASTER WS4
1.1		B100-RS-EH/0 MASTER WS4
2.0		MTPAD-MHWO MASTER WS4
2.1		MTPADPROX MASTER WS4

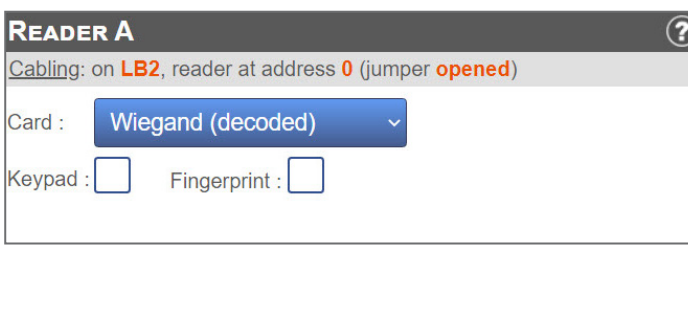

### 5.2 WIEGAND 32 BIT

- In the **Settings/Configuration of the reader** select **“Wiegand 32bit RAW”**, the one shown in the picture below.

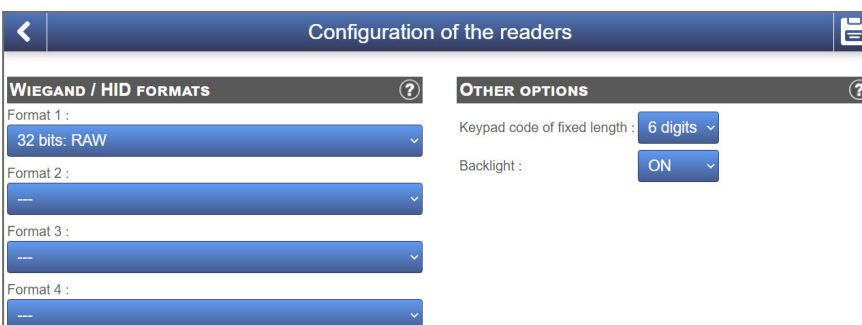
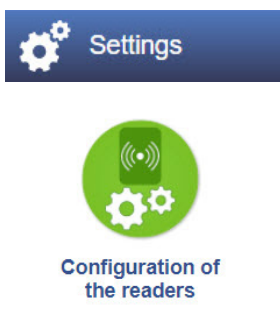

- In the **Doors/Reader/Card** tab select **“Wiegand (decoded)”**.

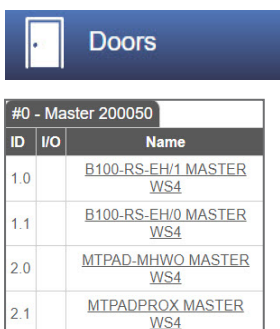

ID	I/O	Name
1.0		B100-RS-EH/1 MASTER WS4
1.1		B100-RS-EH/0 MASTER WS4
2.0		MTPAD-MHWO MASTER WS4
2.1		MTPADPROX MASTER WS4

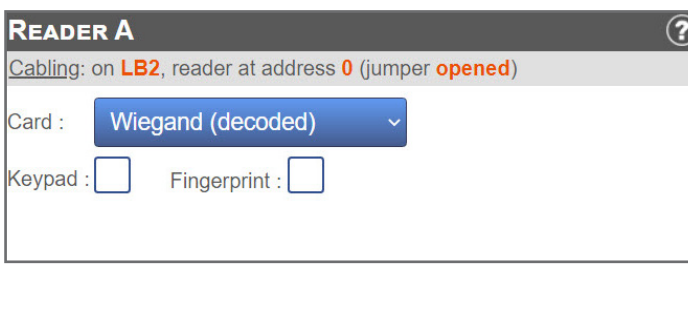

## MANUEL DE L'UTILISATEUR

### 1. DESCRIPTION

Ce convertisseur permet de connecter n'importe quel type de lecteur (Wiegand, Data/Clock ISO2, Dallas et RS-232) au bus local des unités d'accès. Ce convertisseur adapte automatiquement ses entrées (D1/CLK/Dal et DO/DTA/Rx) à la sortie du lecteur.

### 2. CARACTÉRISTIQUES

- Consommation de courant sans éléments externes: 30 mA
- Tension de sortie de 13,8 V CC: max. 300 mA
- Entrée anti-sabotage
- Dimensions (mm): 54 x 30

### 3. DESCRIPTIONS DES COMMUTATEUR DIP ET DES BORNIERIS

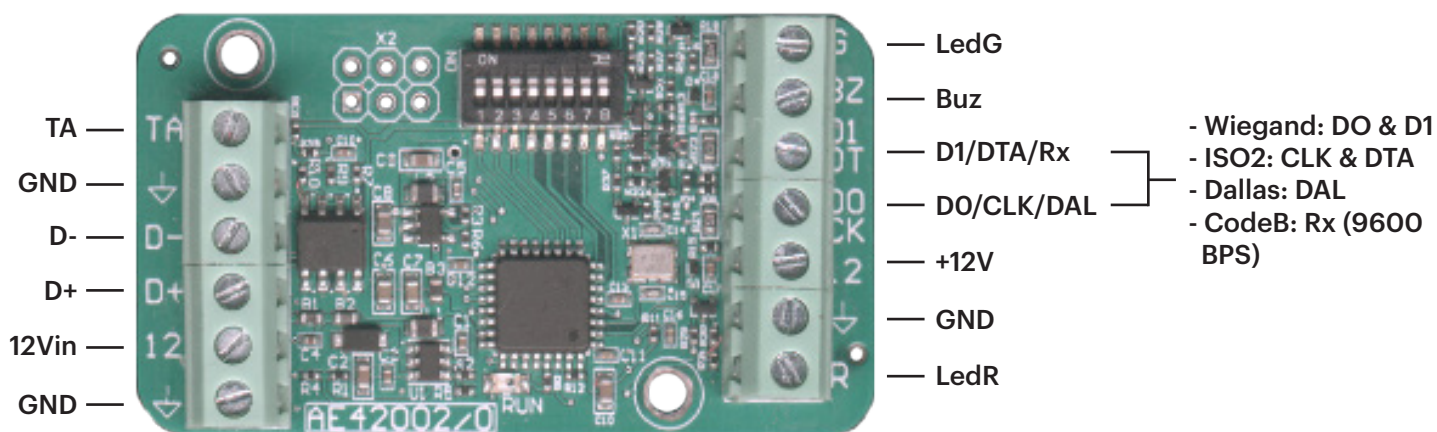

#### Réglage des LED du lecteur

Pour régler le comportement des LED, consultez le manuel du lecteur et réglez les commutateur DIP selon le tableau ci-dessous.

Couleur des LED du lecteur		Orange		Rouge		Vert		ÉTEINTE	
Positions des commutateur DIP	Type	LedR	LedG	LedR	LedG	LedR	LedG	LedR	LedG
/	/	/	Z	/	Z	/	Z	/	Z
DIP 4	1 Fil	/	Z	/	LO	/	HI	/	Z
DIP 3	1 Fil	/	Z	/	HI	/	LO	/	Z
DIP 3 & 4	2 Fils	LO	LO	LO	Z	Z	LO	Z	Z
DIP 2	2 Fils	LO	LO	Z	LO	LO	Z	Z	Z
DIP 2 & 4	2 Fils	Z	Z	Z	LO	LO	Z	LO	LO
DIP 2 & 3	2 Fils	Z	Z	LO	Z	Z	LO	LO	LO
DIP 2, 3 & 4	2 Fils	HI	HI	HI	Z	Z	HI	Z	Z
DIP 1	2 Fils	HI	HI	Z	HI	HI	Z	Z	Z
DIP 1 & 4	2 Fils	Z	Z	Z	HI	HI	Z	HI	HI
DIP 1 & 3	2 Fils	Z	Z	HI	Z	Z	HI	HI	HI

**Légende**  
**Z:** Haute impédance/ three state  
**LO:** 0 volt  
**HI:** +5 volts

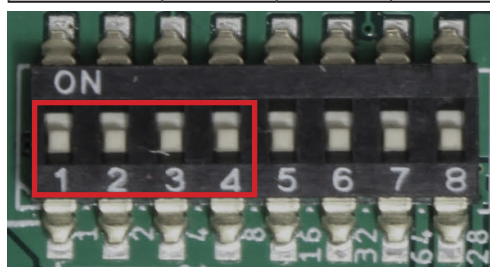



À partir de la version 2.03!!!

• **COMMUTATEUR DIP 7 MARCHE:**

Mode Wiegand: désactive l'option permettant d'utiliser un pavé numérique Wiegand.

• **COMMUTATEUR DIP 7 ARRÊT:**

Mode Wiegand : un pavé numérique Wiegand peut être utilisé sur l'entrée D0/D1.

Le pavé numérique doit être configuré en clé unique (Wiegand 8 bits) Nibbles Complémenté.

• **COMMUTATEUR DIP 8 MARCHE:** Adresse 0.

• **COMMUTATEUR DIP 8 ARRÊT:** Adresse 1.

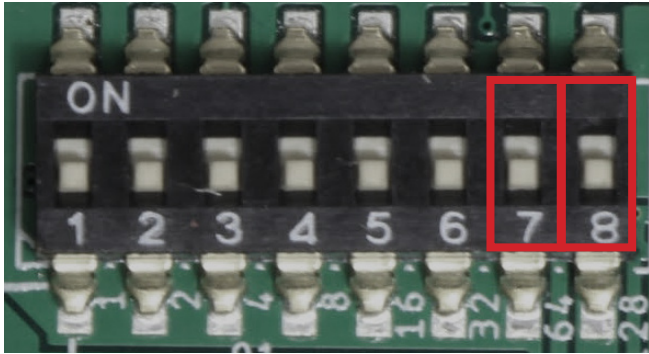

## 4. SCHÉMA DES CONNEXIONS

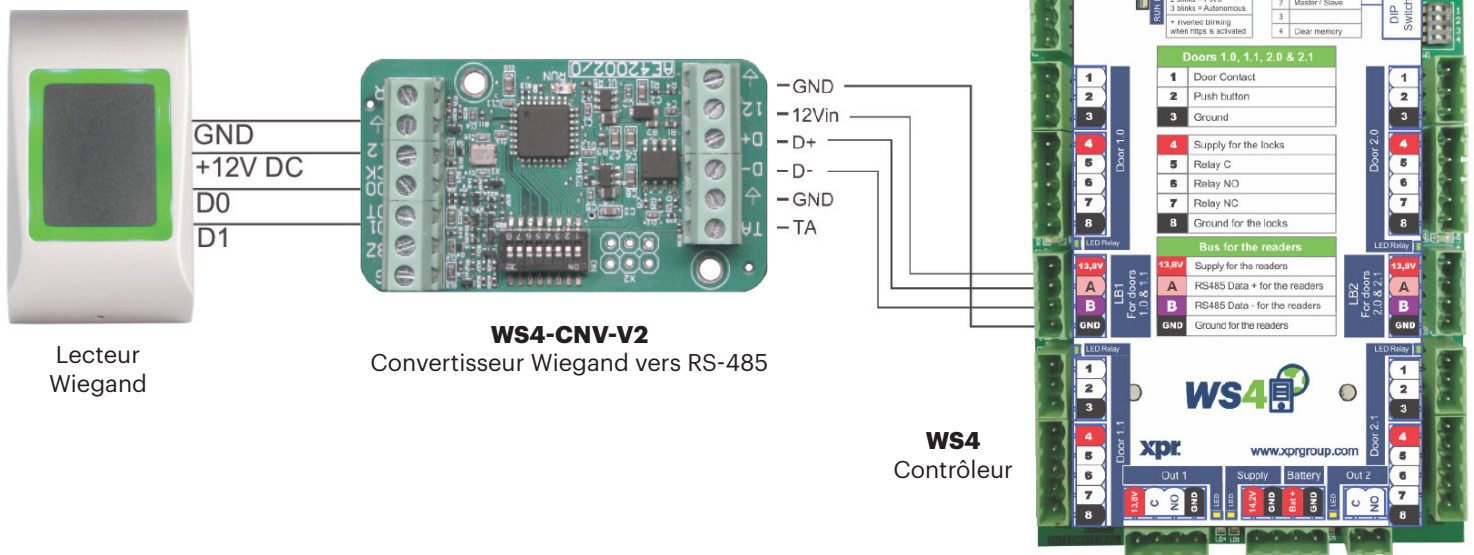

- Choisissez l'entrée Wiegand souhaitée du lecteur.
- Connectez le lecteur Wiegand au convertisseur tel que l'indique l'image ci-dessus.
- Saisissez l'adresse de votre choix pour le commutateur DIP (0 ou 1).
- Définissez les paramètres du lecteur dans le logiciel WS4.

## 5. PARAMÈTRES DU LOGICIEL

### 5.1 WIEGAND 26 BIT

- Dans **Configuration/Options système**, sélectionnez **“Wiegand 26bit”**, l’option indiquée dans l’image ci-dessous.



- Dans **Portes/Lecteur/Badge**, sélectionnez **“Wiegand (decoded)”**.



### 5.2 WIEGAND 32 BIT

- Dans **Configuration/Options système**, sélectionnez **“Wiegand 32bit RAW”**, l’option indiquée dans l’image ci-dessous.

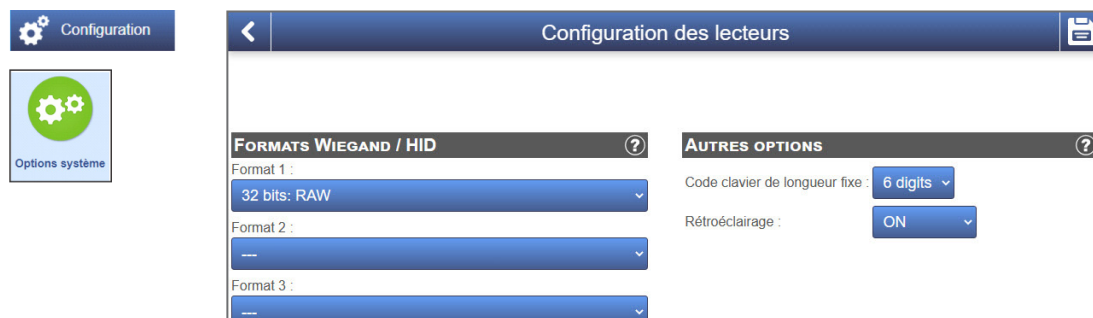

- Dans **Portes/Lecteur/Badge**, sélectionnez **“Wiegand (decoded)”**.



## MANUALE PER L'UTENTE

### 1. DESCRIZIONE

Questo convertitore consente la connessione di qualsiasi tipo di lettore (Wiegand, Data/Clock ISO2, Dallas e RS-232) al bus locale delle unità di accesso. Il convertitore adatta automaticamente i suoi ingressi (D1/CLK/Dal e D0/DTA/Rx) all'uscita del lettore.

### 2. SPECIFICHE TECNICHE

- Consumo di corrente senza elementi esterni: 30 mA
- Uscita 13,8 Vdc: max. 300 mA
- Ingresso tamper
- Dimensioni (mm): 54 x 30

### 3. DESCRIZIONE DI DIPSWITCH E MORSETTI TERMINALI

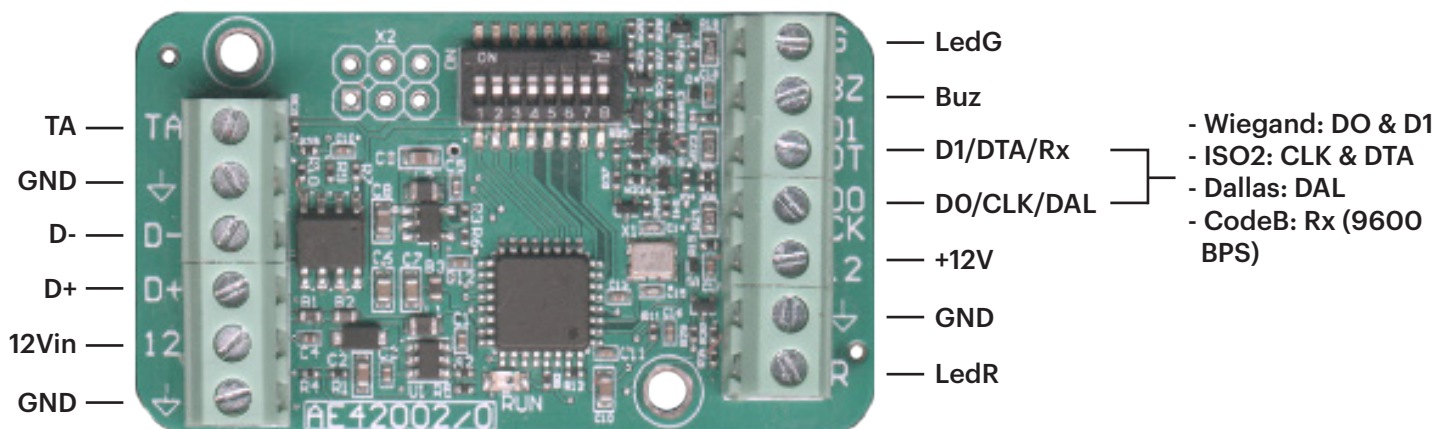

#### Configurazione dei LED del lettore

Per configurare il comportamento dei LED, consultare il manuale del lettore e posizionare i DIP switch seguendo la tabella sottostante.

Colore dei LED del lettore LEDs color		Arancione		Rosso		Verde		OFF	
Posizione dei Dip Switch	Typo	LedR	LedG	LedR	LedG	LedR	LedG	LedR	LedG
/	/	/	Z	/	Z	/	Z	/	Z
DIP 4	1 Cavo	/	Z	/	LO	/	HI	/	Z
DIP 3	1 Cavo	/	Z	/	HI	/	LO	/	Z
DIP 3 & 4	2 Cavi	LO	LO	LO	Z	Z	LO	Z	Z
DIP 2	2 Cavi	LO	LO	Z	LO	LO	Z	Z	Z
DIP 2 & 4	2 Cavi	Z	Z	Z	LO	LO	Z	LO	LO
DIP 2 & 3	2 Cavi	Z	Z	LO	Z	Z	LO	LO	LO
DIP 2, 3 & 4	2 Cavi	HI	HI	HI	Z	Z	HI	Z	Z
DIP 1	2 Cavi	HI	HI	Z	HI	HI	Z	Z	Z
DIP 1 & 4	2 Cavi	Z	Z	Z	HI	HI	Z	HI	HI
DIP 1 & 3	2 Cavi	Z	Z	HI	Z	Z	HI	HI	HI

**Leggenda**  
**Z:** Impedenza alta/ three state  
**LO:** 0 volt  
**HI:** +5 volt

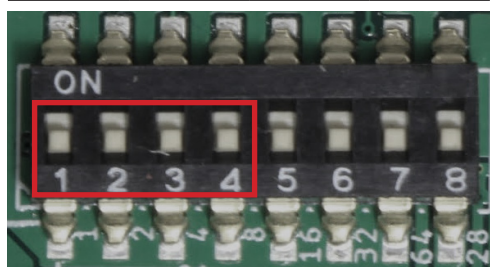

Dalla versione 2.03!!!

• **DIPSWITCH 7 ON:**

Modo Wiegand: disabilita la possibilità di utilizzare un tastierino Wiegand.

• **DIPSWITCH 7 OFF:**

Modo Wiegand: può essere utilizzato un tastierino Wiegand per l'ingresso D0/D1;

Il tastierino deve essere configurato come tasto singolo - 8 bit Wiegand - Nibbles Integrato.

• **DIPSWITCH 8 ON:** Indirizzo 0.

• **DIPSWITCH 8 OFF:** Indirizzo 1.

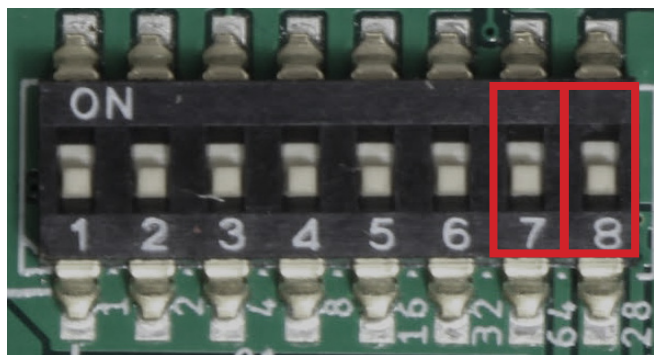

#### 4. DIAGRAMMA DI CONNESSIONE

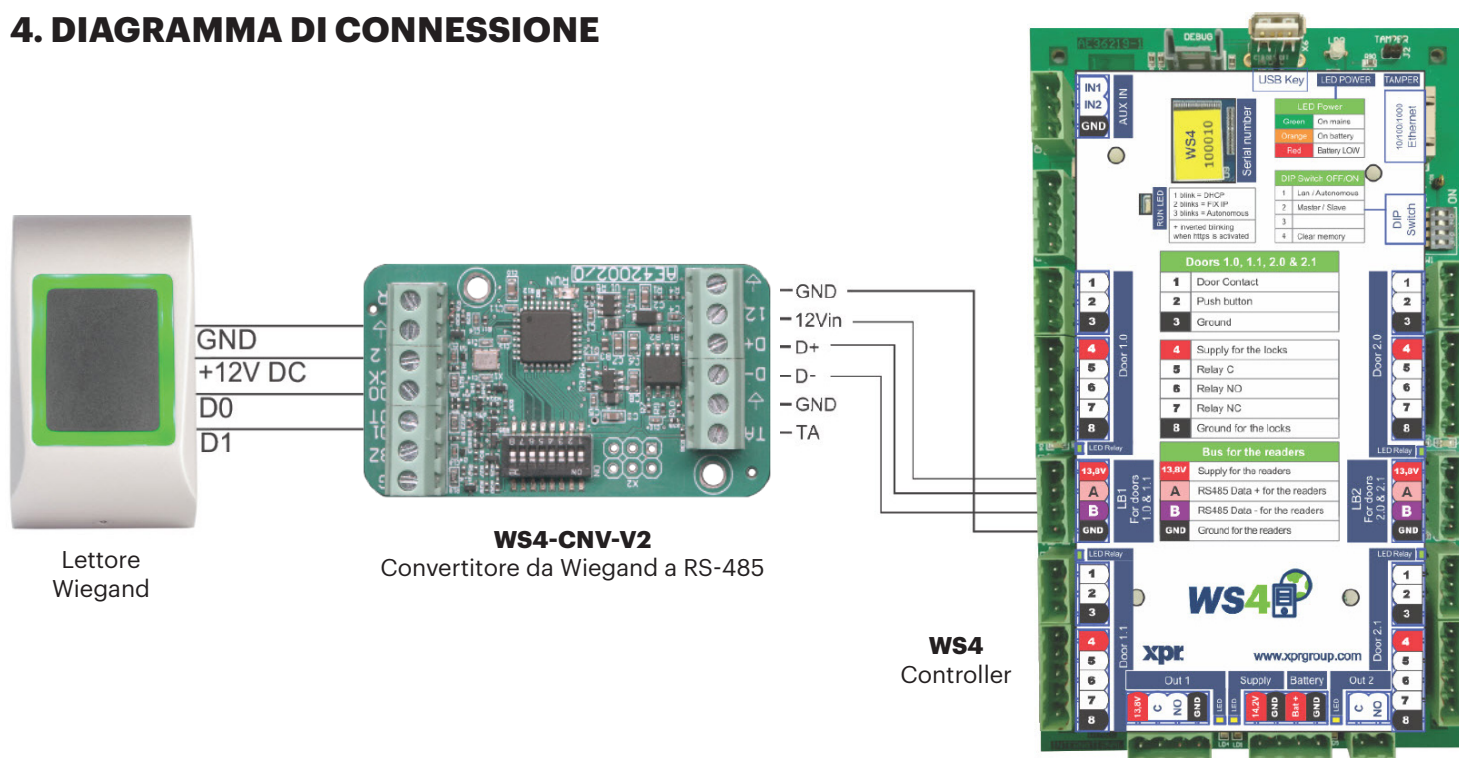

- Impostare l'uscita Wiegand desiderata del lettore.
- Collegare il lettore Wiegand al convertitore come mostrato nella figura precedente.
- Collocare il Dip Switch dell'indirizzo nel convertitore sull'indirizzo desiderato del convertitore , 0 o 1.
- Configurare i parametri del lettore nel software WS4.



## 5. IMPOSTAZIONI DEL SOFTWARE

### 5.1 WIEGAND 26 BIT

- In **Impostazioni/Opzioni di sistema**, selezionare **“Wiegand 26bit”**, come mostrato nella figura sottostante.

Impostazioni

Opzioni di sistema

Configurazione dei lettori

**FORMATO WIEGAND / HID**

Formato 1 : 26 bits: RAW

Formato 2 : ---

Formato 3 : ---

Formato 4 : ---

**ALTRE OPZIONI**

Codice tastiera di lunghezza fissa : 6 digits

Backlight : ON

- In **Porte/Lettore/Scheda**, selezionare **“Wiegand (decoded)”**.

Porte

ID	I/O	Nome
1.0		B100-RS-EH/1 MASTER WS4
1.1		B100-RS-EH/0 MASTER WS4
2.0		MTPAD-MHWO MASTER WS4

LETTORE A

Cablaggio: su LB2, lettore su indirizzo 1 (ponte chiusa)

Scheda : Wiegand (decoded)

Tastiera :  Impronta digitale :

Periodi obbligatori per scheda + PIN :

### 5.2 WIEGAND 32 BIT

- In **Impostazioni/Opzioni del sistema**, selezionare **“Wiegand 32bit RAW”**, come mostrato nella figura sottostante.

Impostazioni

Opzioni di sistema

Configurazione dei lettori

**FORMATO WIEGAND / HID**

Formato 1 : 32 bits: RAW

Formato 2 : ---

Formato 3 : ---

**ALTRE OPZIONI**

Codice tastiera di lunghezza fissa : 6 digits

Backlight : ON

- In **Porte/Lettore/Scheda**, selezionare **“Wiegand decoded”**.

Porte

ID	I/O	Nome
1.0		B100-RS-EH/1 MASTER WS4
1.1		B100-RS-EH/0 MASTER WS4
2.0		MTPAD-MHWO MASTER WS4

LETTORE A

Cablaggio: su LB2, lettore su indirizzo 1 (ponte chiusa)

Scheda : Wiegand (decoded)

Tastiera :  Impronta digitale :

Periodi obbligatori per scheda + PIN :

## MANUAL DE USUARIO

### 1. DESCRIPCIÓN

Este convertidor permite la conexión de cualquier tipo de lector (Wiegand, de datos/fichas ISO2, Dallas y RS-232) al bus local de las unidades de acceso. El convertidor adapta automáticamente sus entradas (D1/CLK/Dal y DO/DTA/Rx) a la salida del lector.

### 2. ESPECIFICACIONES

- Consumo de corriente sin elementos externos: 30 mA
- Salida 13,8 V CC: máx. 300 mA
- Entrada manual
- Dimensiones (mm): 54 x 30

### 3. DESCRIPCIÓN DE INTERRUPTOR DIP Y BLOQUES DE TERMINALES

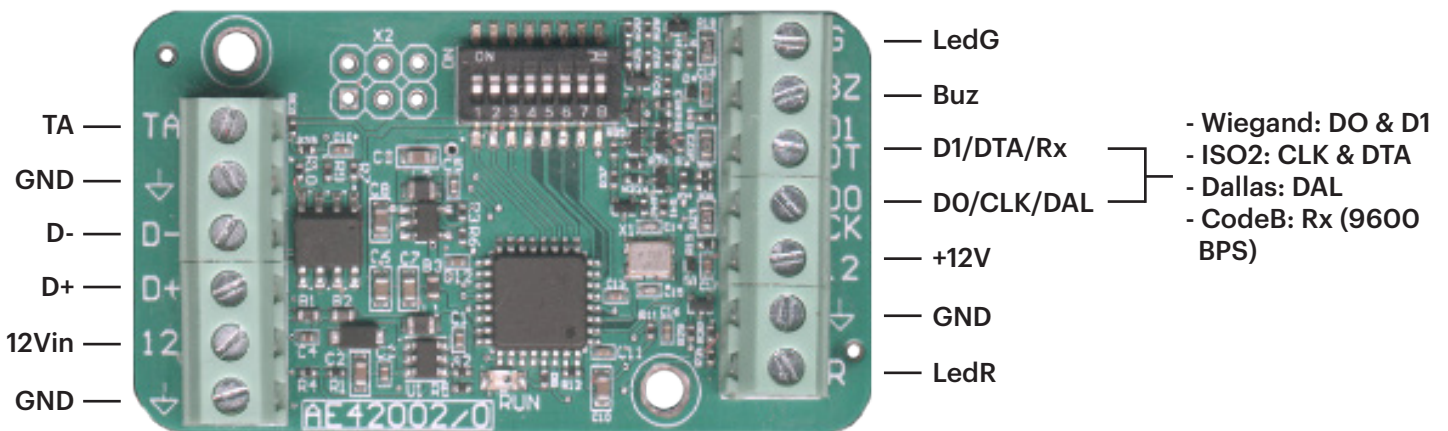

#### Reader's LEDs configuration

Para configurar el comportamiento de los LED, consulte el manual del lector y coloque los interruptor DIP de acuerdo con la tabla siguiente.

Color de los LED del lector		Naranja		Rojo		Verde		Apagado	
Posiciones de interruptor DIP	Type	LedR	LedG	LedR	LedG	LedR	LedG	LedR	LedG
/	/	/	Z	/	Z	/	Z	/	Z
DIP 4	1 Cable	/	Z	/	LO	/	HI	/	Z
DIP 3	1 Cable	/	Z	/	HI	/	LO	/	Z
DIP 3 & 4	2 Cables	LO	LO	LO	Z	Z	LO	Z	Z
DIP 2	2 Cables	LO	LO	Z	LO	LO	Z	Z	Z
DIP 2 & 4	2 Cables	Z	Z	Z	LO	LO	Z	LO	LO
DIP 2 & 3	2 Cables	Z	Z	LO	Z	Z	LO	LO	LO
DIP 2, 3 & 4	2 Cables	HI	HI	HI	Z	Z	HI	Z	Z
DIP 1	2 Cables	HI	HI	Z	HI	HI	Z	Z	Z
DIP 1 & 4	2 Cables	Z	Z	Z	HI	HI	Z	HI	HI
DIP 1 & 3	2 Cables	Z	Z	HI	Z	Z	HI	HI	HI

**Leyenda**  
**Z:** Alta impedancia/ three state  
**LO:** 0 voltios  
**HI:** +5 voltios

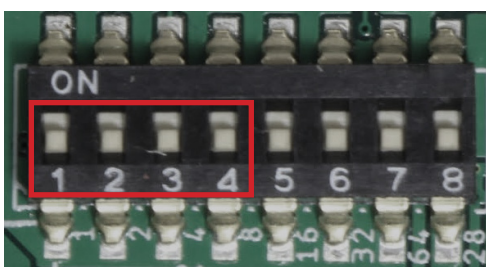

A partir de la versión 2.03!!!

• **INTERRUPTOR DIP 7 ENCENDIDO:**

Modo Wiegand: desactiva la posibilidad de utilizar un teclado Wiegand.

• **INTERRUPTOR DIP 7 APAGADO:**

Modo Wiegand: se puede utilizar un teclado Wiegand en la entrada D0/D1;

El teclado debe configurarse en una sola tecla - Wiegand de 8 bits - Complementado con Nibbles.

• **INTERRUPTOR DIP 8 ENCENDIDO:** Dirección 0.

• **INTERRUPTOR DIP 8 APAGADO:** Dirección 1.

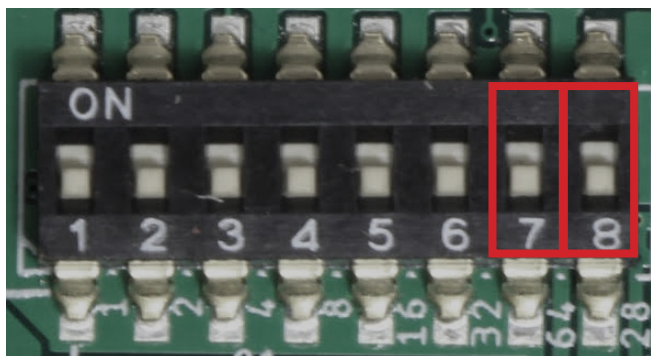

### 4. DIAGRAMA DE CONEXIÓN

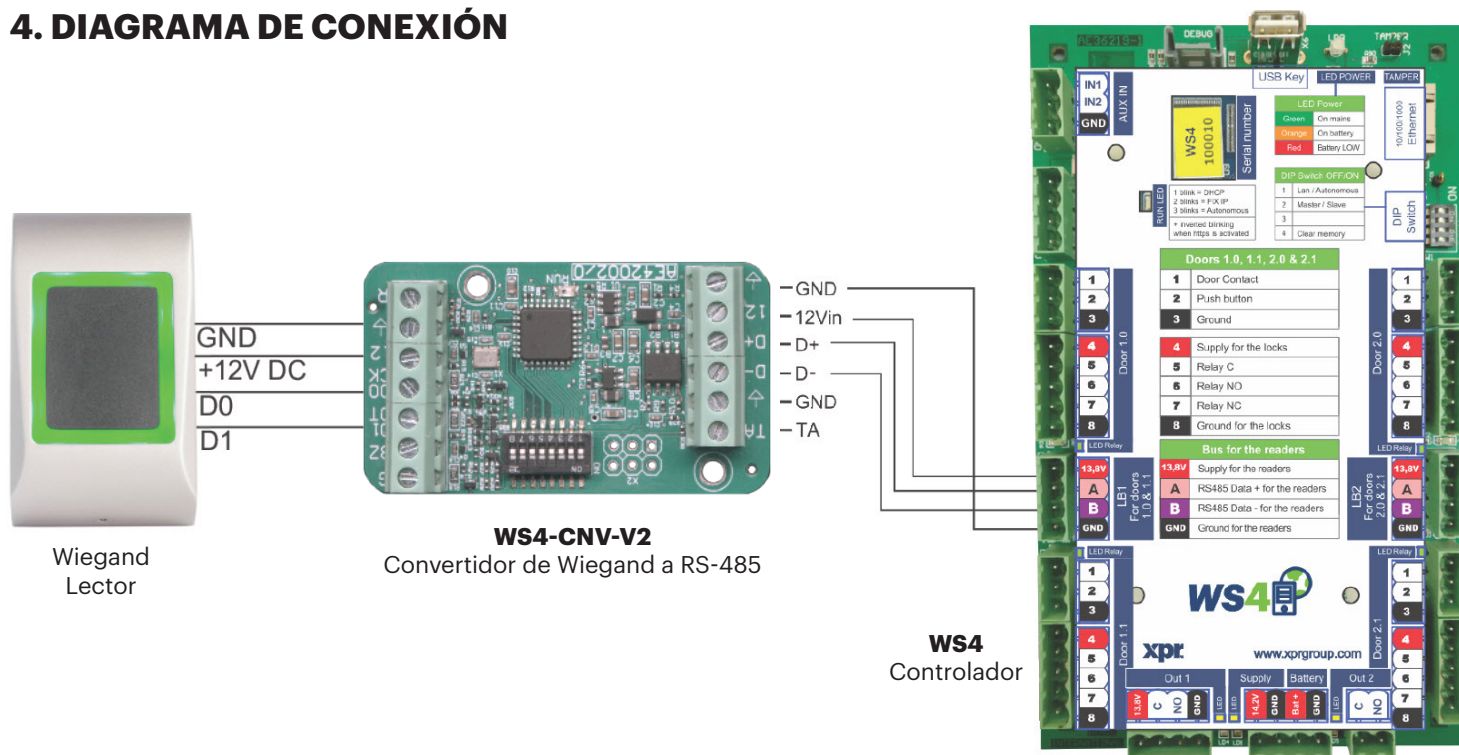

- Establezca la salida Wiegand deseada del lector.
- Conecte el lector Wiegand al convertidor como se muestra en la imagen anterior.
- Coloque el interruptor DIP de direcciones del convertidor en la dirección deseada, 0 o 1.
- Configure los parámetros del lector en el software WS4.

## 5. AJUSTES DE SOFTWARE

### 5.1 WIEGAND 26 BIT

- En **Configuración/Opciones del sistema**, seleccione **“Wiegand 26bit”**, como se muestra en la imagen siguiente.

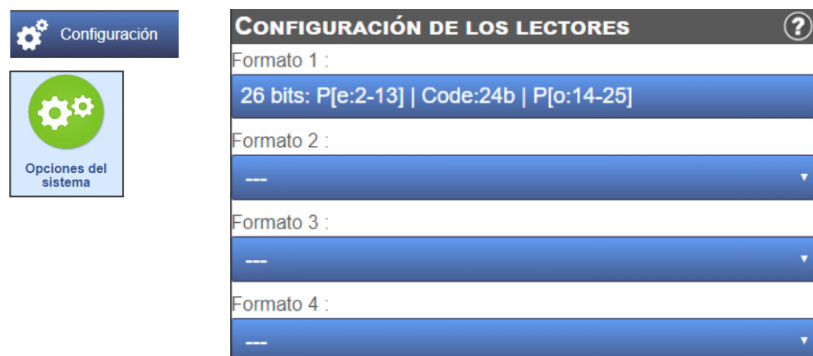

- En **Puertas/Lector/Tarjeta** seleccione **“Wiegand (decoded)”**.

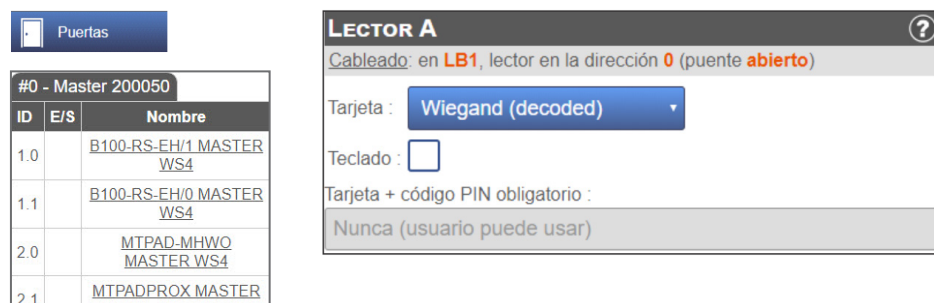

### 5.2 WIEGAND 32 BIT

- En **Configuración/Opciones del sistema**, seleccione **“Wiegand 32bit RAW”**, como se muestra en la imagen siguiente.

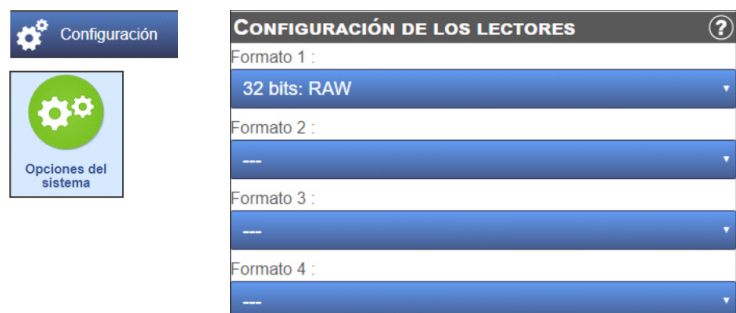

- En **Puertas/Lector/Tarjeta** seleccione **“Wiegand (decoded)”**.

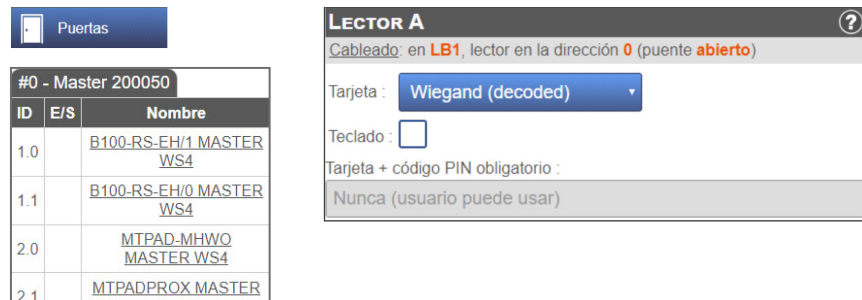



## BENUTZERHANDBUCH

### 1. BESCHREIBUNG

Der Konverter ermöglicht die Verbindung jedes Lesertyps (Wiegand, Data / Clock ISO2, Dallas und RS-232) mit der lokalen Busleitung der Zutrittseinheiten. Der Konverter passt seine Eingänge (D1/CLK/Dal und DO/DTA/Rx) automatisch an die Ausgänge des Lesers an.

### 2. GERÄTEMERKMALE

- Stromaufnahme ohne externe Geräte: 30 mA
- Ausgangsspannung 13,8 VDC: max. 300 mA
- Sabotageeingang
- Abmessungen (mm): 54 x 30

### 3. ÜBERSICHT DER DIP SCHALTER UND ANSCHLUSSKLEMMEN

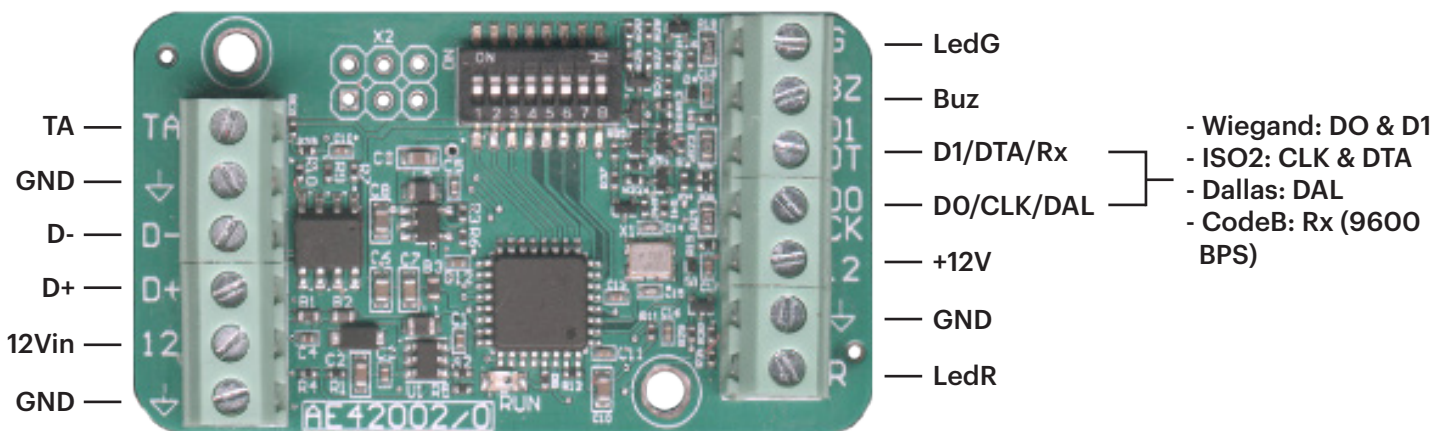

#### Konfiguration der LEDs des Lesers

Hinweise zur Konfiguration der LEDs finden Sie im Benutzerhandbuch. In der Tabelle unten finden Sie eine Übersicht zur Einstellung der DIP Schalter.

Farben der LEDs des Lesers		Orange		Rot		Grün		AUS	
Dip Schalter positionen	Typo	LedR	LedG	LedR	LedG	LedR	LedG	LedR	LedG
/	/	/	Z	/	Z	/	Z	/	Z
DIP 4	1-Adrig	/	Z	/	LO	/	HI	/	Z
DIP 3	1-Adrig	/	Z	/	HI	/	LO	/	Z
DIP 3 & 4	2-Adrig	LO	LO	LO	Z	Z	LO	Z	Z
DIP 2	2-Adrig	LO	LO	Z	LO	LO	Z	Z	Z
DIP 2 & 4	2-Adrig	Z	Z	Z	LO	LO	Z	LO	LO
DIP 2 & 3	2-Adrig	Z	Z	LO	Z	Z	LO	LO	LO
DIP 2, 3 & 4	2-Adrig	HI	HI	HI	Z	Z	HI	Z	Z
DIP 1	2-Adrig	HI	HI	Z	HI	HI	Z	Z	Z
DIP 1 & 4	2-Adrig	Z	Z	Z	HI	HI	Z	HI	HI
DIP 1 & 3	2-Adrig	Z	Z	HI	Z	Z	HI	HI	HI

**Legende**  
**Z:** Hochohmig/  
 three state  
**LO:** 0 volt  
**HI:** +5 volt

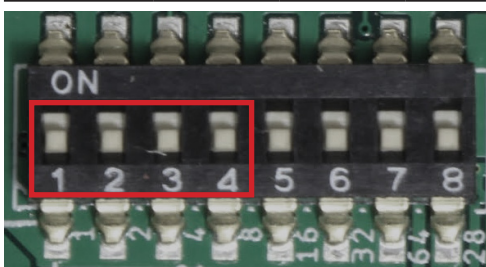

Ab Version 2.03!!!

• **DIP-SCHALTER 7 EIN:**

Wiegandmodus: die Funktion der Wiegandtastatur ist deaktiviert.

• **DIP-SCHALTER 7 AUS:**

Wiegandmodus: Wiegandtastatur kann über den D0/D1-Eingang betrieben werden;

Die Konfiguration der Tastatur erfolgt über Single Key - 8-Bit-Wiegand - Nibbles komplementiert.

• **DIP-SCHALTER 8 EIN:** Adresse 0.

• **DIP-SCHALTER 8 AUS:** Adresse 1.

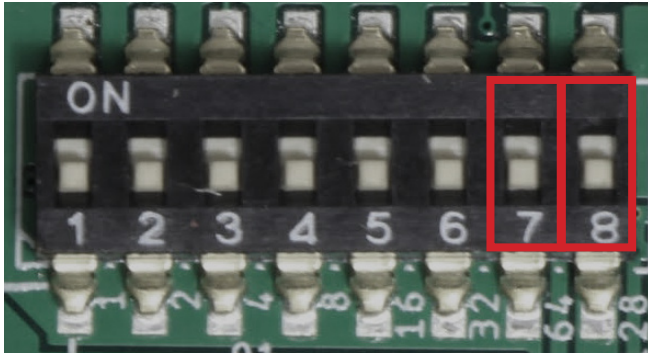

## 4. ÜBERSICHT DER VERDRÄHTUNG

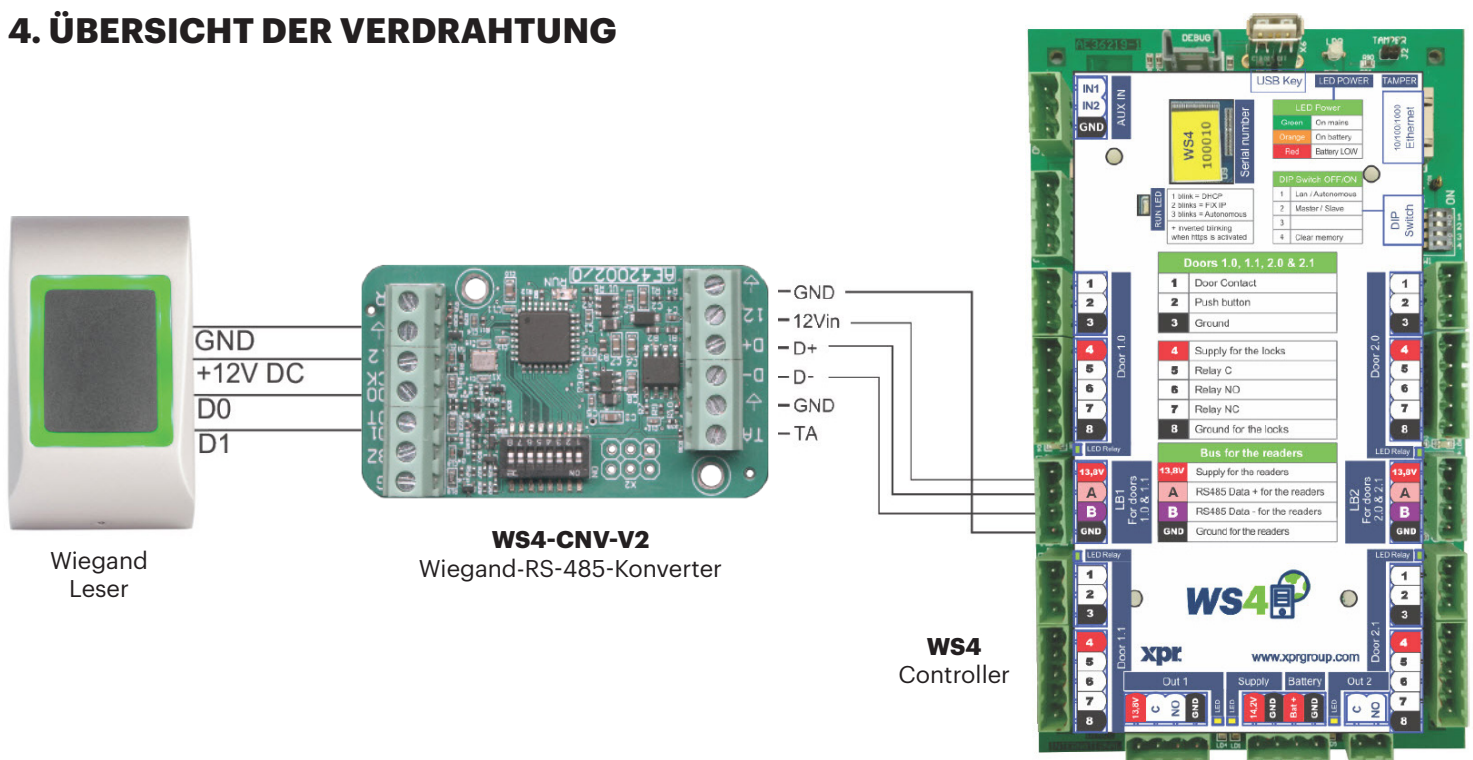

- Wählen Sie den gewünschten Wiegand-Ausgang des Lesers.
- Verbinden Sie den Wiegandleser mit dem Konverter, wie in der Abbildung oben dargestellt.
- Stellen Sie den DIP-Schalter positionen des Konverters auf die gewünschte Adresse ein, 0 oder 1.
- Nehmen Sie in der WS4-Software die gewünschten Einstellungen für den Leser vor.

## 5. SOFTWAREEINSTELLUNGEN

### 5.1 26-BIT-WIEGAND

- Wählen Sie unter **Einstellungen/Systemoptionen** "Wiegand 26bit", siehe Abbildung unten.

**Einstellungen**

**Systemoptionen**

**Konfiguration der Zutrittsleser**

**WIEGAND / HID FORMAT**

Format 1 : 26 bits: RAW

Format 2 : ---

Format 3 : ---

Format 4 : ---

**WEITERE OPTIONEN**

Tastaturcode mit vorgegebener Länge : 6 digits

Hintergrundbeleuchtung : ON

- Wählen Sie unter **Türen/Leser/Karte** "Wiegand (decoded)".

**Türen**

ID	E/A	Name
1.0		B100-RS-EH/1 MASTER WS4
1.1		B100-RS-EH/0 MASTER WS4
2.0		MTPAD-MHWO MASTER WS4
2.1		MTPADPROX

**LESER A**

Verdrahtung: mit LB2, Leser an Adresse1 (jumper geschlossen)

Karte : Wiegand (decoded)

Tastatur :  Fingerabdruck :

Karte + PIN-Code-pflichtige Zeiträume :

### 5.2 32-BIT-WIEGAND

- Wählen Sie unter **Einstellungen/Systemoptionen** "Wiegand 32bit RAW", siehe Abbildung unten.

**Einstellungen**

**Systemoptionen**

**Konfiguration der Zutrittsleser**

**WIEGAND / HID FORMAT**

Format 1 : 32 bits: RAW

Format 2 : ---

Format 3 : ---

**WEITERE OPTIONEN**

Tastaturcode mit vorgegebener Länge : 6 digits

Hintergrundbeleuchtung : ON

- Wählen Sie unter **Türen/Leser/Karte** "Wiegand (decoded)".

**Türen**

ID	E/A	Name
1.0		B100-RS-EH/1 MASTER WS4
1.1		B100-RS-EH/0 MASTER WS4
2.0		MTPAD-MHWO MASTER WS4
2.1		MTPADPROX

**LESER A**

Verdrahtung: mit LB2, Leser an Adresse1 (jumper geschlossen)

Karte : Wiegand (decoded)

Tastatur :  Fingerabdruck :

Karte + PIN-Code-pflichtige Zeiträume :

# GEBRUIKERSHANDLEIDING

## 1. OMSCHRIJVING

Met deze converter kan elk type reader (Wiegand, Data / Clock ISO2, Dallas en RS-232) verbinden met de lokale bus van de toegangsapparaten. 3) De converter past automatisch de ingangen (D1/CLK/Dal en DO/DTA/Rx) aan de uitgang van de lezer aan.

## 2. SPECIFICATIES

- Huidig gebruik zonder externe elementen: 30 mA
- Output 13,8 Vdc : max. 300 mA
- Input van tamper
- Afmetingen (mm): 54 x 30

## 3. OMSCHRIJVING DIP SWITCH EN KLEMMENBLOKKEN

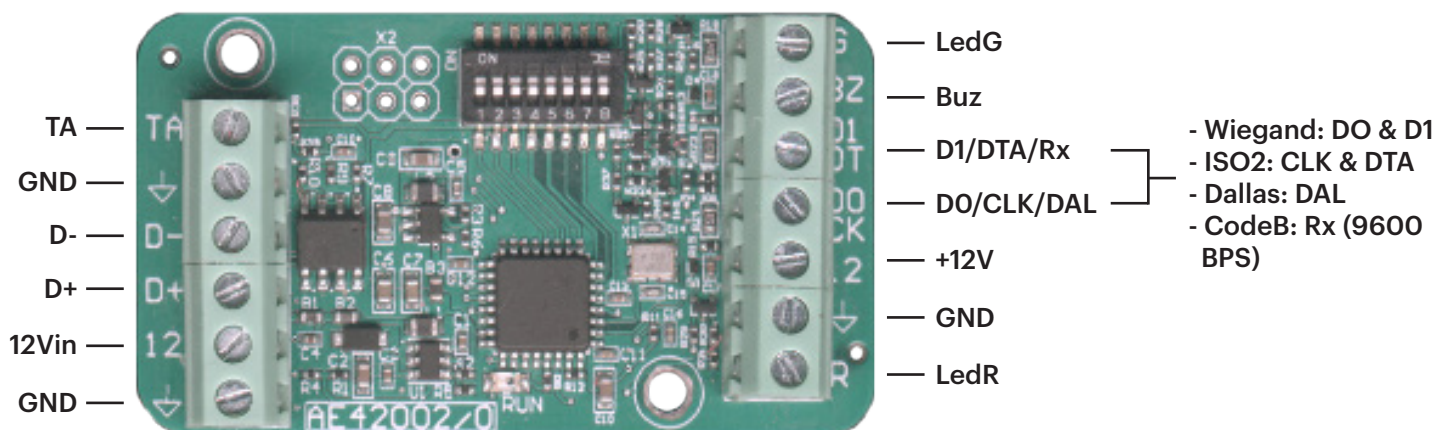

### Configuratie leds van de lezer

Om de instelling van de leds te configureren, dient u de handleiding te raadplegen en de DIP Switch in te stellen volgens de tabel die hieronder wordt weergegeven.

Kleur leds lezer		Oranje		Rood		Groen		UIT	
Posities Dip Switch	Type	LedR	LedG	LedR	LedG	LedR	LedG	LedR	LedG
/	/	/	Z	/	Z	/	Z	/	Z
DIP 4	1 Draad	/	Z	/	LO	/	HI	/	Z
DIP 3	1 Draad	/	Z	/	HI	/	LO	/	Z
DIP 3 & 4	2 Draden	LO	LO	LO	Z	Z	LO	Z	Z
DIP 2	2 Draden	LO	LO	Z	LO	LO	Z	Z	Z
DIP 2 & 4	2 Draden	Z	Z	Z	LO	LO	Z	LO	LO
DIP 2 & 3	2 Draden	Z	Z	LO	Z	Z	LO	LO	LO
DIP 2, 3 & 4	2 Draden	HI	HI	HI	Z	Z	HI	Z	Z
DIP 1	2 Draden	HI	HI	Z	HI	HI	Z	Z	Z
DIP 1 & 4	2 Draden	Z	Z	Z	HI	HI	Z	HI	HI
DIP 1 & 3	2 Draden	Z	Z	HI	Z	Z	HI	HI	HI

**Legende**  
**Z:** Hoge impedantie/ three state  
**LO:** 0 volt  
**HI:** +5 volt

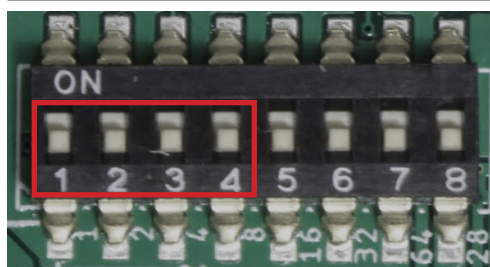





## 5. SOFTWARE INSTELLINGEN

### 5.1 WIEGAND 26 BIT

- Selecteer in **Configuratie/Systeemopties "Wiegand 26bit"**, zoals op de afbeelding hieronder staat.

The screenshot shows the 'Configuratie van de lezers' (Reader Configuration) screen. On the left, there is a sidebar with 'Configuratie' and 'Systeemopties' (System Options). The main area is divided into two sections: 'WIEGAND / HID FORMATEN' and 'OVERIGE OPTIES'. Under 'WIEGAND / HID FORMATEN', 'Formaat 1' is set to '26 bits: RAW'. Under 'OVERIGE OPTIES', 'Vaste code lengte' is set to '6 digits' and 'Achtergrondverlichting' is set to 'ON'.

- Selecteer in **Deuren/Lezer/Kaart "Wiegand (decoded)"**.

The screenshot shows the 'Deuren' (Doors) configuration screen. On the left, there is a table of door configurations. The main area is titled 'LEZER A' and shows 'Aansluiten: op LB2, lezer op adres 1 (jumper gesloten)'. The 'Kaart' (Card) is set to 'Wiegand (decoded)'. There are checkboxes for 'Keypad' and 'Vingerafdruk' (Fingerprint), both of which are currently unchecked. Below these, it says 'Kaart + pincode verplicht:'.

#0 - Master 200050		
ID	I/U	Naam
1.0		B100-RS-EH/1 MASTER WS4
1.1		B100-RS-EH/0 MASTER WS4
2.0		MTPAD-MHWO MASTER WS4
2.1		MTPADPROX MASTER WS4

### 5.2 WIEGAND 32 BIT

- Selecteer in **Configuratie/Systeemopties "Wiegand 32bit RAW"**, zoals op de afbeelding hieronder staat.

The screenshot shows the 'Configuratie van de lezers' (Reader Configuration) screen. On the left, there is a sidebar with 'Configuratie' and 'Systeemopties' (System Options). The main area is divided into two sections: 'WIEGAND / HID FORMATEN' and 'OVERIGE OPTIES'. Under 'WIEGAND / HID FORMATEN', 'Formaat 1' is set to '32 bits: RAW'. Under 'OVERIGE OPTIES', 'Vaste code lengte' is set to '6 digits' and 'Achtergrondverlichting' is set to 'ON'.

- Selecteer in **Deuren/Lezer/Kaart "Wiegand (decoded)"**.

The screenshot shows the 'Deuren' (Doors) configuration screen. On the left, there is a table of door configurations. The main area is titled 'LEZER A' and shows 'Aansluiten: op LB2, lezer op adres 1 (jumper gesloten)'. The 'Kaart' (Card) is set to 'Wiegand (decoded)'. There are checkboxes for 'Keypad' and 'Vingerafdruk' (Fingerprint), both of which are currently unchecked. Below these, it says 'Kaart + pincode verplicht:'.

#0 - Master 200050		
ID	I/U	Naam
1.0		B100-RS-EH/1 MASTER WS4
1.1		B100-RS-EH/0 MASTER WS4
2.0		MTPAD-MHWO MASTER WS4
2.1		MTPADPROX MASTER WS4